

# ICE-CREAM ALLITERATION!



# ICE-CREAM ALLITERATION!

Name: \_\_\_\_\_

ICE CREAM MENU



---

---

---

---

---

---

primary stannoniens

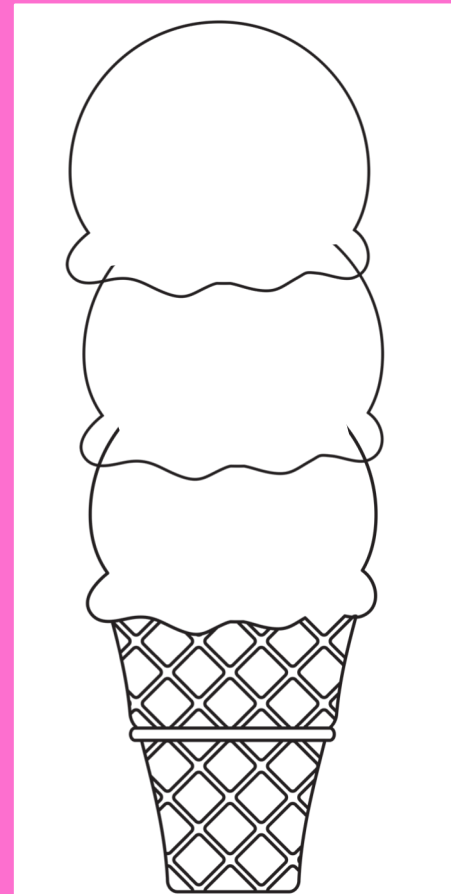

# ICE-CREAM ALLITERATION!

- Read the poem ["Bleezer's Ice-Cream" by Jack Prelutsky](#)
- Follow up with this fun alliteration activity where students can create their OWN crazy ice-cream flavors!
- Check out my [Poetry Elements Visual Aids](#) to support your Poetry Unit!

Name: \_\_\_\_\_

# ICE CREAM MENU

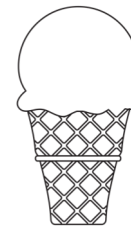

Handwriting practice area consisting of ten sets of horizontal lines. Each set includes a solid top line, a dashed middle line, and a solid bottom line, providing a guide for letter height and placement.

Name: \_\_\_\_\_

# ICE CREAM MENU

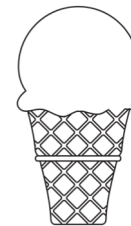

---

---

---

---

---

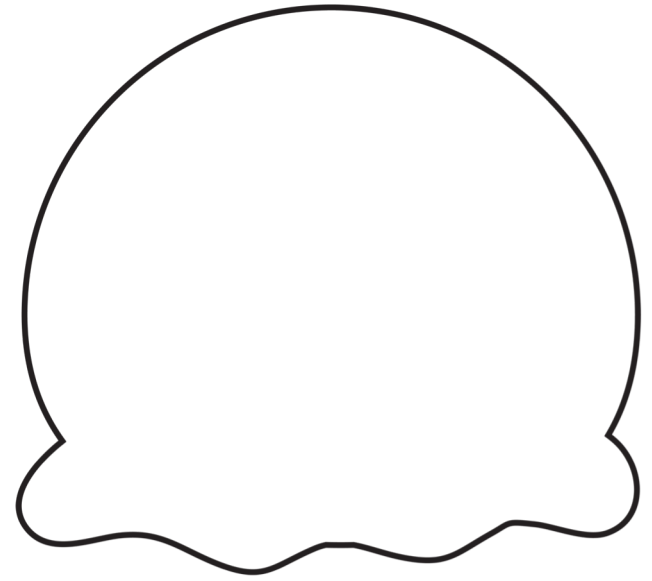
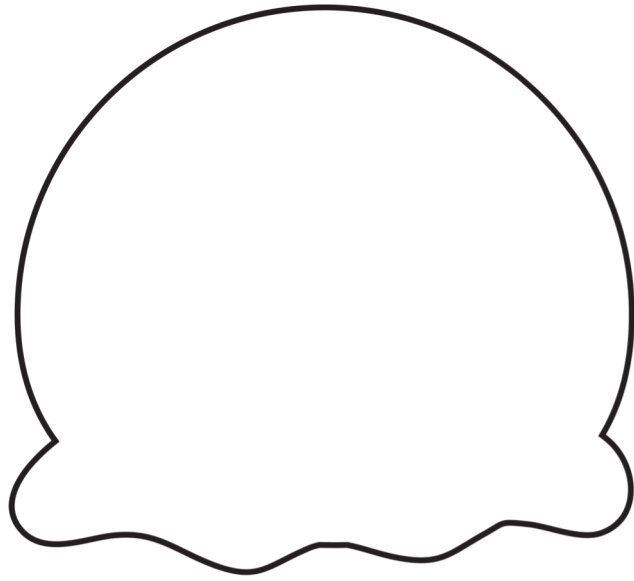
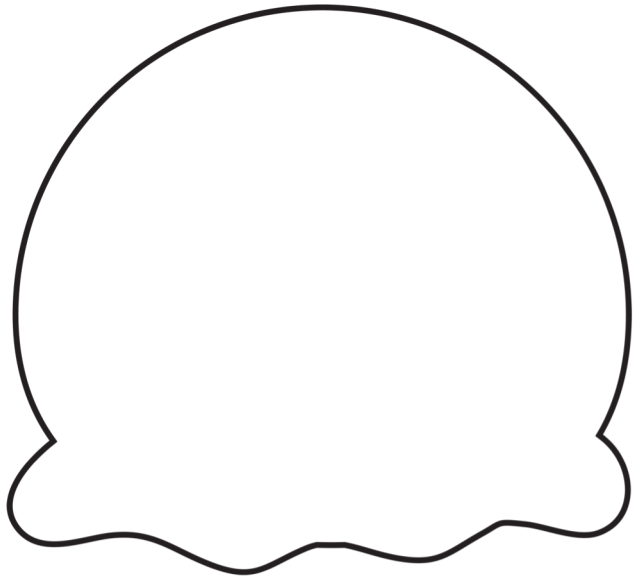

STUDENTS MAY WRITE/DESIGN THEIR CRAZY FLAVORS ON THE SCOOPS  
OF ICE-CREAM

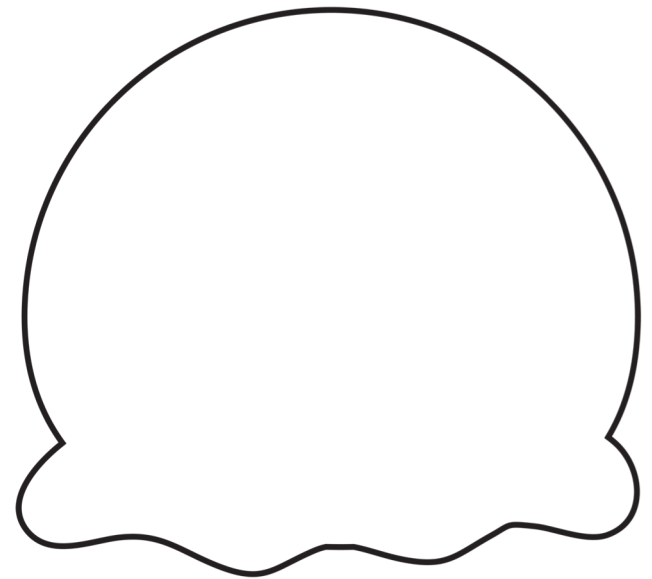
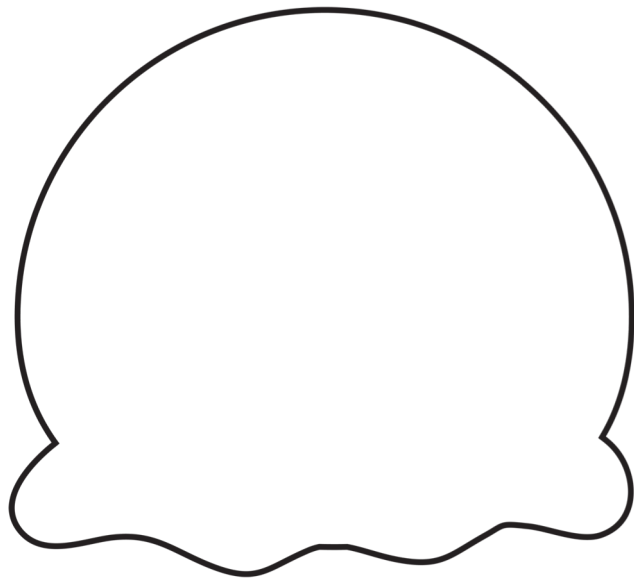
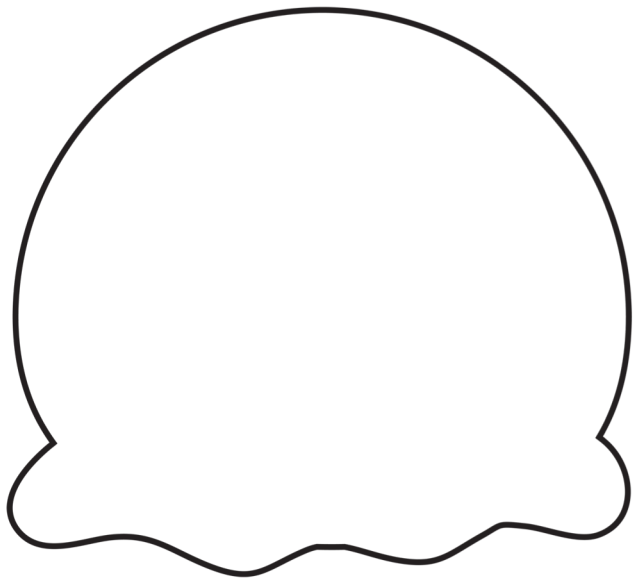

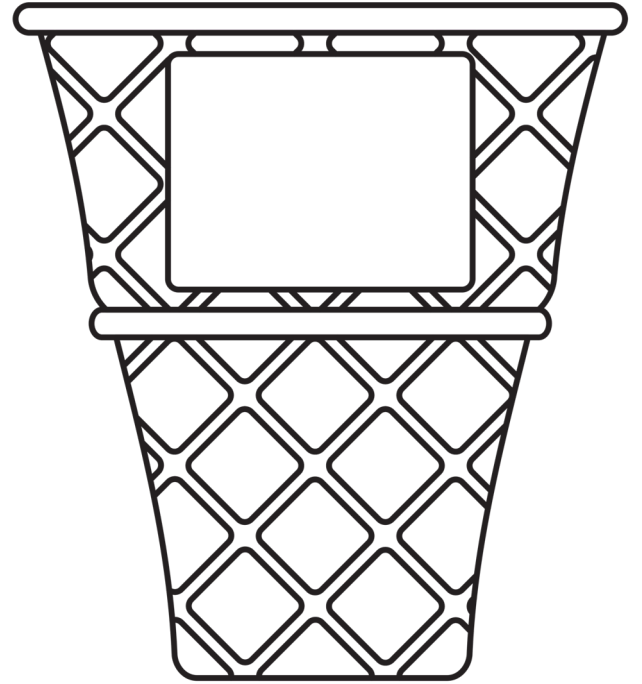
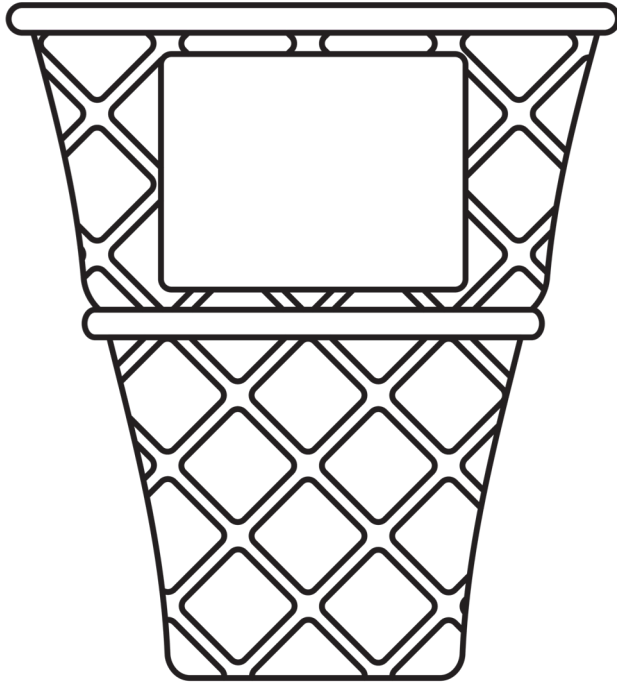
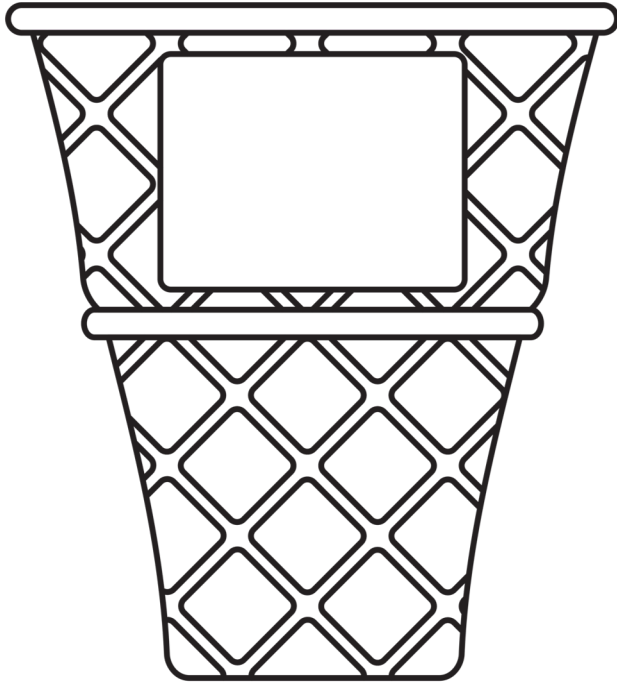

ICE-CREAM CREATION

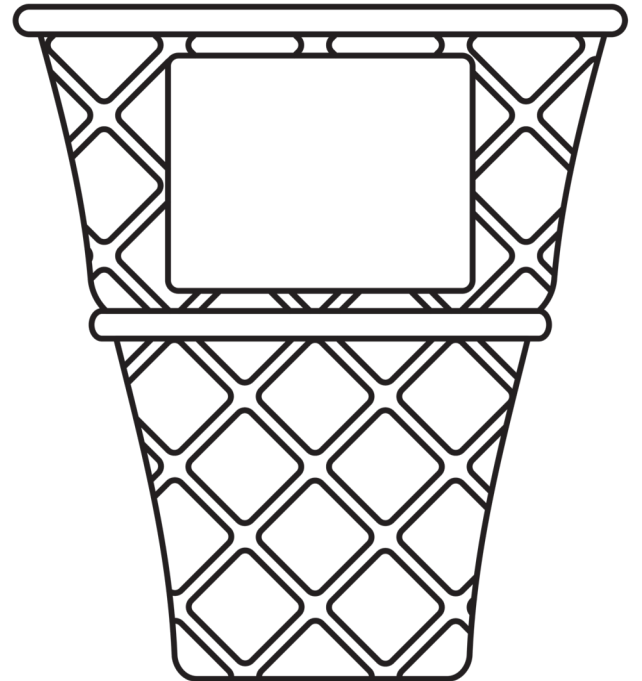
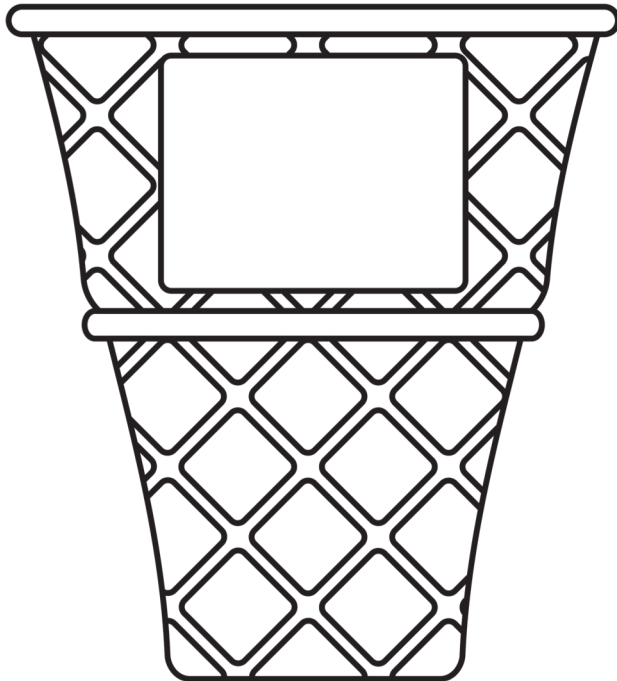
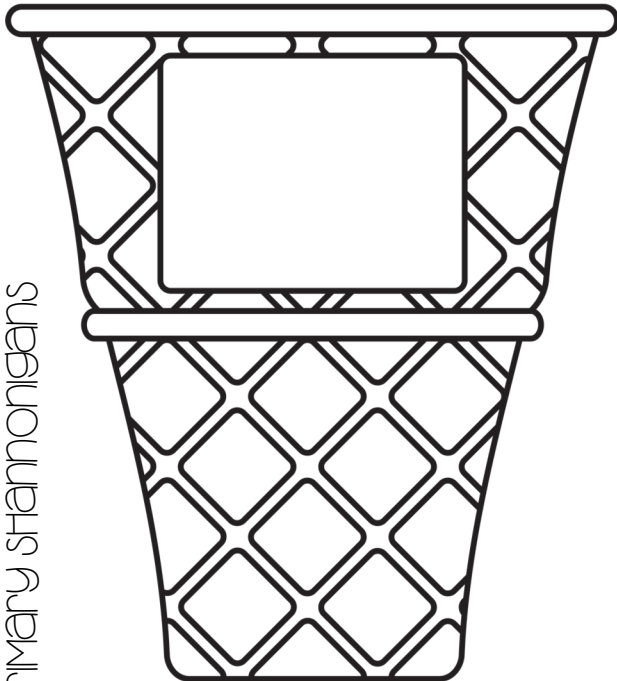



TMC  
WRITING  
LINES

